

GSM Alarm System User Guider

GSM+PSTN+Contact ID

1

2

3

4

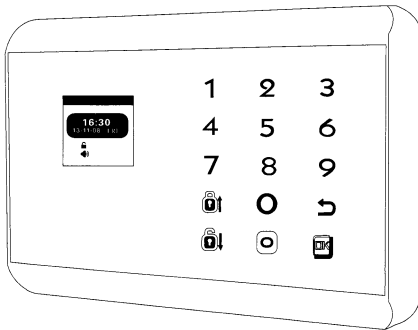

Menu

Part I, Packing Details and System Feature	2
Part II, Setup Ready To Use	6
Part III ,System Setting By Keyboard and APP	11
Part IV, CID Monitor Center Setting	23
Part V, Query Alarm System	27
Part VI, Default Factory Setting and System Parameters	28
Part VII, How to Install Sensor	29
Part VIII, Troubleshooting	31

Part I, Packing Details and System Feature.

1. Packing Details:

1 x Panel, 1 x PIR, 1 x Door Sensor, 2 x Remote, 1 x Power Adapter, and Few Brackets.

2. The Original Password:

1234. The password will be asked when User call or SMS to panel.

3. System Functions

(A) TFT color display, humanized menu, voice prompt and easy to use.

(B) Up to 99 wireless zones, each wireless zones can be defined as one of the 8 zone types, each zone can setup the siren independently.

(C) Four groups of scheduled arm/disarmed function, each timed arm /disarm you can select the period of time and different defense zone

(D) 6 groups preset telephone number for alert calling; not lost number without power

(E) Support ISD automatic voice mailbox for playback message upon alert. Maximum length of voice message is 10 seconds.

(F) Remote control for arming, disarming, monitoring and speaking, setting up for relay and siren.

(G) Wireless intelligent study coding, compatible with PT2262 normal encoding and 1527 encoding, Maximum support 150 remote control and 150 sensors.

(H) Integrated clock chip, time will not lose without power

(I) Unique black box feature, display most recent 72 disarmed records and 102 recent alarm recording with accurate alarm time and zones.

(J) Compatible with the international alarm networking protocol CONTACT ID

4. Alarm Feature

Install alarm panel at the central of apartment, panel will easy to connect with all the wireless sensors and accessories. Keep the panel away from large metal objects or appliances with high-frequency interference, and avoid barriers such as concrete walls with metal frame inside and fire doors.

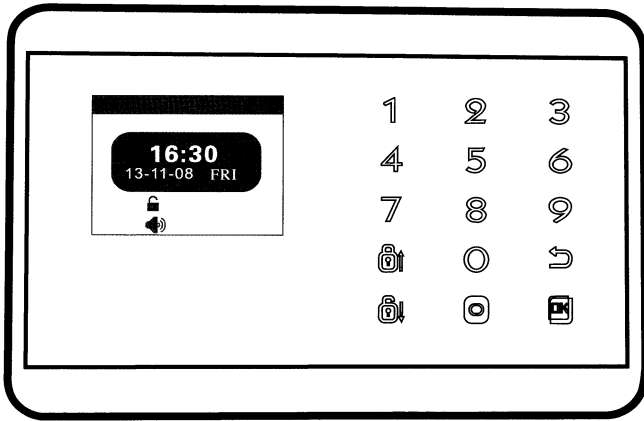

The front of the host

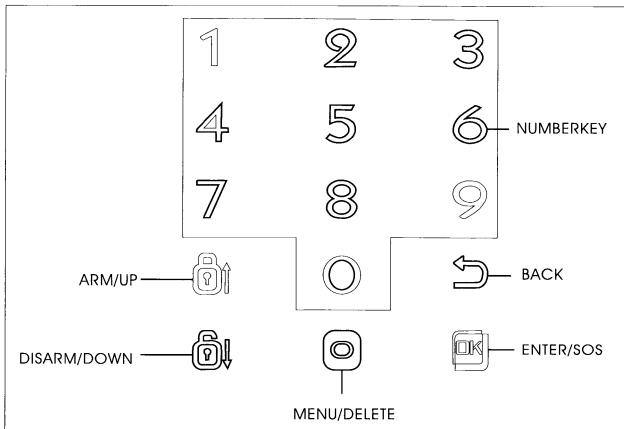

The touch-key of the host

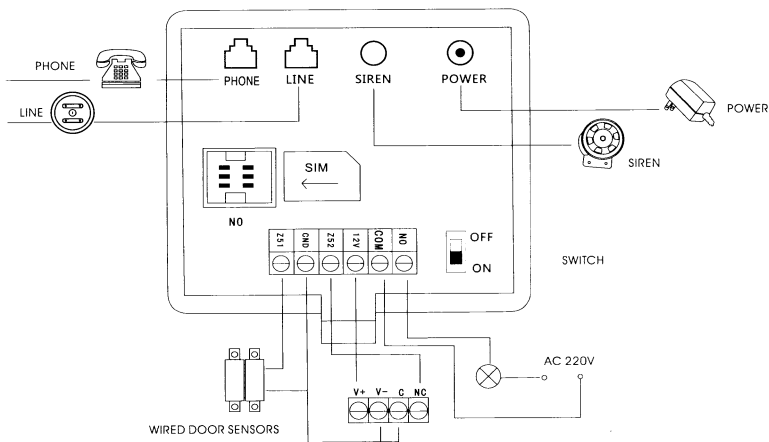

the connection method of wired door sensor and PIR sensor

■ Notice

TFT display	Display "DISARM"	Alarm host in DISARM status
	Display "ARM"	Alarm host in ARM status
	Display "STAY ARM"	Alarm host in STAY ARM status
	Display "XX zone arming"	XX zone in a ARM status,
	Display "98 zone arming"	Emergency arming by pressing the emergency button
	Display "97 zone arming"	The host was defused or moved
	"SIM Card" light	SIM Card loaded correctly

5 Alarm Process

5.1 Alarm process description and Monitoring Call

ARM→Detectors was triggered, Send signal to the panel→The host will alarm→Panel report the alarm to the CID center/ call/SMS to the user
→User receive the phone/SMS and remote control the panel.

5.2 Remote control the Panel :

User can operate the alarm system by phone call: User will not be asked for password upon host call, but User will be asked for password upon User Call to the host. Alarm will automatically hang up call after no operation within 20 seconds.

The Operation are:

- | | |
|---|--------------------------------|
| [1] key: arming | [2] key: disarming |
| [3] key: monitoring open | [4] key: monitoring closed |
| [5] key: turn on announcement | [6] key: turn off announcement |
| [7] key: siren ringing | [8] key: stop siren sound |
| [9] key: turn on relay | [0] key: turn off relay |
| [*] key: hang up, system will not dial the next number on list. | |

Remark:

For host alarm call: If not hang up with [*] key or disarm with [2] key, the system will retry to call the next phone numbers on list until one connected.

Note: the monitoring and announcement time is 20 seconds, please press [3] or [5] key to continue if you need.

5.2 ALARM SCHEMATICS

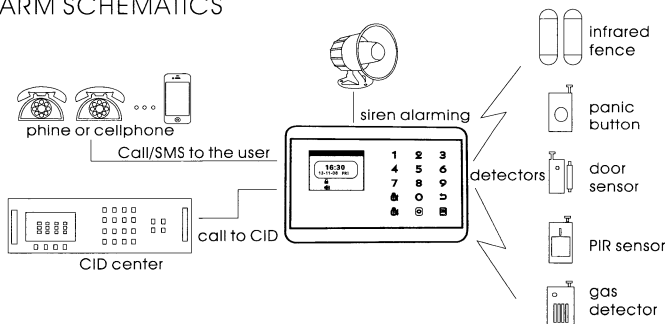

Part II Setup Ready To Use

Alarm System Basic Settings and Working Mode



1, Alarm Panel Initial Setup

Step 1: Connect the external phone line, subline, siren, sim card and power adapter rightly to the panel. (Adapter keep power off at this time.)

Step 2: Turn on the battery switch, panel will voice prompt "Welcome to use alarm system"

Step 3: Power on the adapter.

Add/Delete Accessories

Press **【menu】**  to enter main menu. Press **【2】**  to enter Add accessories. As Picture 5-1

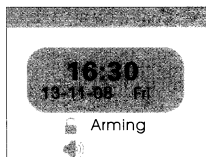

Press **【menu】**

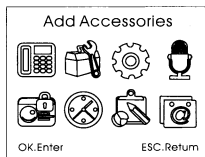

Press **【2】**

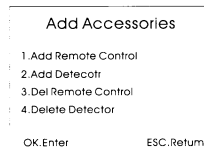

Picture 5-1

1.1 Add Remote Control



Press **【1】** to enter 'Add Remote Control'→Input Zone Number you want to add remote control→then press  →press any key of the remote control to send a signal to the alarm panel→ press  panel voice "Set successful" and LCD display "has been saved"→ to back.

Remarks: a, If beep only once means this remote control was configured before and cannot be added again. b, If want to add more remote control in this zone, can press any key of other remote control. Alarm panel can configure up to 150 remote control.

1.2 Delete Remote Control

As picture 5-1, press **【3】** → Input Zone No.(0-99) or (press **【**】** to delete all remote controls)→ press  to delete certain zones remote control or all remote controls.

1.3 Add Detector

As picture 5-1, press **【2】** → Input Zone No. (0-99)→ → Press  → trigger the detector to send a signal → Panel beep twice, voice prompt "Set successful" and LCD display "has been saved" →  to back

Remarks: a, If beep only once means this detector was configured before and cannot be added again. b, If want to add more detector in the same zone, can trigger other detector. Alarm panel can configure up to 150 detectors .

1.4 Delete Detector

As picture 5-1, Press **【4】** → Input Zone No (press **【**】** to delete all zones) → press  to delete certain zones detector or all detectors.

2. APP Installation and Initial Setup.

User can download the APP by name 'GSM Smart Alarm System' from Android Market, Google Play, IOS APP market. Then, Install it freely, and startup it. This APP support 5 different languages: English, France, Russian, Spanish, Portugal, and Chinese. It will auto-choose the language upon the language of User's mobile device. If User's mobile device adopt other language, the APP will auto-choose English version to install. Initial Setting as below:

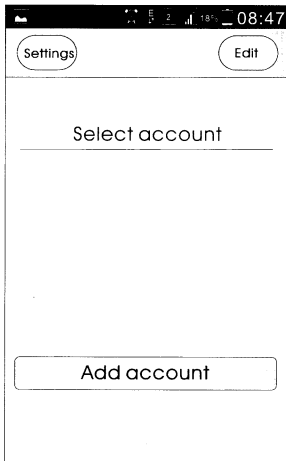

P1

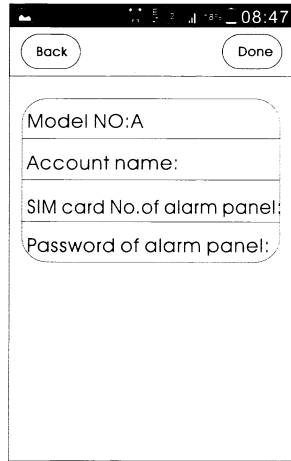

P2

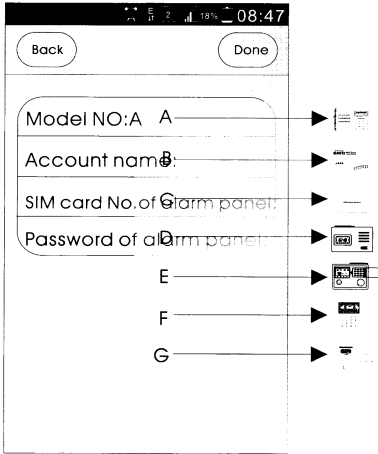

P3

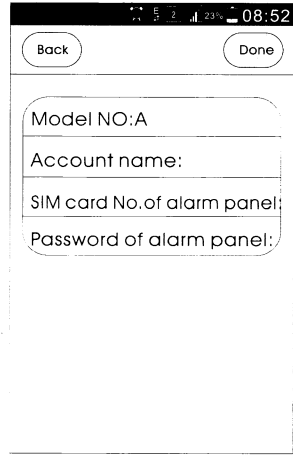

P4

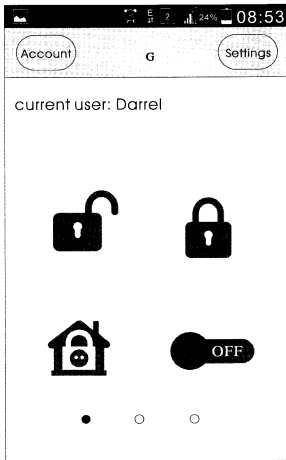

P5

P1: Press Setting for font size and Language

Press 'Ok' return to P1 and Press 'Add Account' to P2

P2: Choose the right Model Number

Create a User Name

Input the Sim card No. Of panel

Input the password of panel.

Press 'Done' to enter P5

3 Introduction of Work Mode (ARM/Disarm/Stay arm/ Emergency Alarm/ Relay)

3.1 Arm

Arm for general protection. In this mode, system will alarm if any detector is triggered.

The panel will display 'Arm'

3.2 DISARM

Disarm for dormant. In this mode, system will not alarm if any detector is triggered.

The Panel will display 'Disarm'

3.3 STAY Arm

Stay Arm means partial protection and partial dormant. In this mode, only alarm for a part of detectors triggered.

The host will display "STAY ALARM",

3.4 Emergency alarm

Emergency: Means User can force the alarm system to alarm in any working mode when emergency occurs.

Remark: If password protect function is open, you need to enter password before other operations, the initial password is 1234.

3.5 Set Relay Output ON/OFF: Use it to power on/off the Appliances.

Methods to Set Above Work Mode:

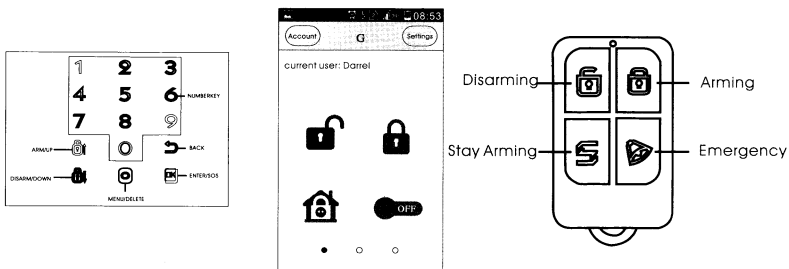

Arm: On panel press / On remote press / on APP click / SMS setting: 1234+1 + #

Disarm: On panel press / On remote press / on APP click / SMS setting 1234+0 + #

Stay arm: On panel double press / On remote press / on APP click / SMS setting 1234+2 + #

Emergency Alarm: On panel press / On remote press /

Turn on/off relay: On panel: Press → Press → press **【5.Phon&SMS setting】** → **【Alarm Out】**, press switch ON or OFF. On means relay short circuit when system alarm / On APP slide / SMS Setting 1234+[3/4] + # (3 means relay on.4 means off.)

Part III System Setting By Panel Keyboard and APP.

1: Phone Number Setting.

1.1 Phone Number Settings

The model can support 6 groups of alarm numbers, 2 groups CID numbers, 3 groups help numbers, 6 groups SMS numbers. Each phone number shouldn't exceed 31 digits. As follow:

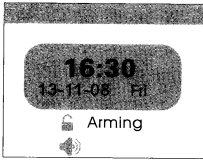

Press **【Menu】**

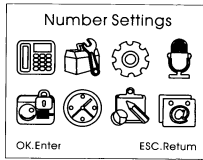

Press **【1】**

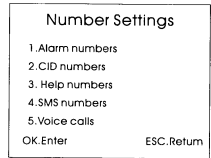

Picture 5-2

1.1.1 Set up voice alarm phone number (Two Method)

Method 1, Set it from panel: Press → Press or to choose , then press → Choose '1. Alarm numbers' and press or press digit '1', Input Group 1-6 and press , input the alarm alert phone number, Press to save it. (You can input 6groups). Press to return.

Method 2, Set it from APP, Page 2:

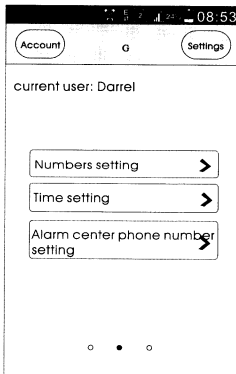

Numbers Setting

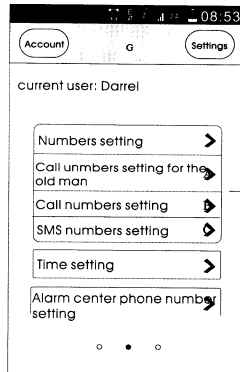

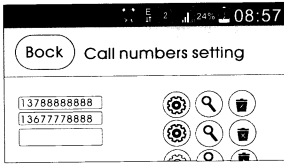

Call Number Setting



User can input 6 alarm phone numbers, then press  one by one to send the numbers to alarm panel. (The same as User send a SMS to the panel sim card: 1234 + 3 + group number + phone number + #)

Remark : If panel connect with line extension, please add a 'digit*' before the alarm phone number.

1.1.2 Delete voice alarm phone number with two Methods:





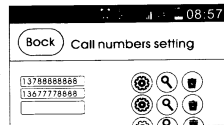





Method 1: Enter '1, Alarm numbers', press  button to delete the number then press  to save the settings.

Method 2: Delete alarm numbers from APP, the No. And press .



Choose

1.2.1 Set up for help alarm phone number with 2 Method.

Method 1: As picture 5-2, Press  , Press  or  to choose  press , Press  or  move the cursor to **【3. Help numbers】** and press  or directly input digit **【3】** to enter help number settings, choose group number 1-3 , then input help number and Press  to save , press  back to the menu.

Method 2: From APP page 2:

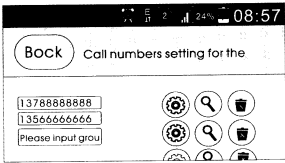
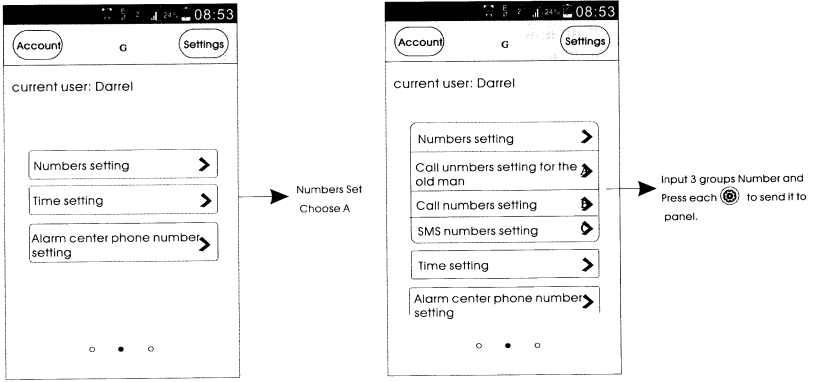

Method 2 is the same as User send a SMS setting: 1 234 + 3 + (Group No. 7-9) + Phone Number + #

Remark : If panel connect with line extension, please add a 'digit*' before the alarm phone number.

1.2.2 Delete for help alarm phone number with 2 methods

Method 1: As picture 5-2, enter **【Help number】** , press [gear icon] button to delete the number than press [save icon] to save the settings. Press [back icon] back to the menu.

Method 2: from APP:

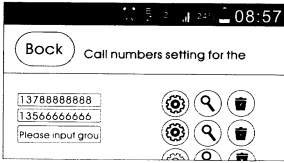

Choose the one you want to delete, press

1.3.1 Set phone number to receive SMS message with two method.

Method 1: As picture 5-2, Press → choose and press , Press or to choose **【4. SMS numbers】** press (or input **【4】**) to enter SMS number settings, choose group number 1-6 , then input SMS number. Press to save, press back to the menu.

Method 2: Set from APP page 2.

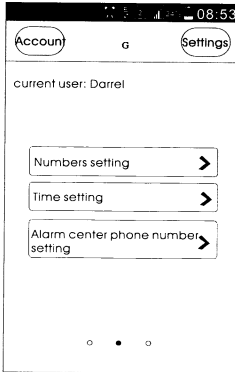

Numbers Setting

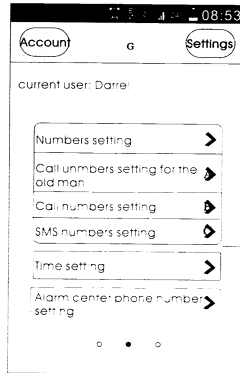

Input Number and press Method 2 is the same as send SMS to panel: 1234 + 4 - group No.(1-6) - phone number - #

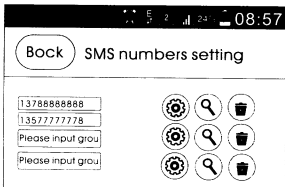

1.3.2 Delete SMS phone number with 2 method:

Method 1: As picture 5-2, enter **[SMS number]** , press button to delete the number, press to save the settings. Press back.

Method 2: From APP Page 2:

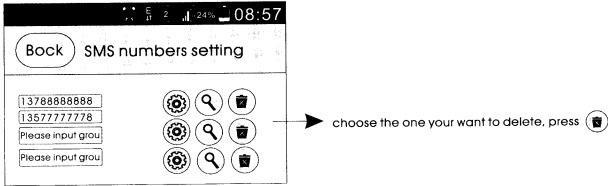

1.3.3 Voice call as Telephone Voice call is

As picture 5-2, Press → → choose **[5. Voice calls]** press , (or press number **[5]** directly) then input number, Press to dial, press hang up the call.

2: DIY System Setting

2.1 Pre-record Voice Message

Alarm panel will play a pre-recorded voice message in the alarm call. As follow

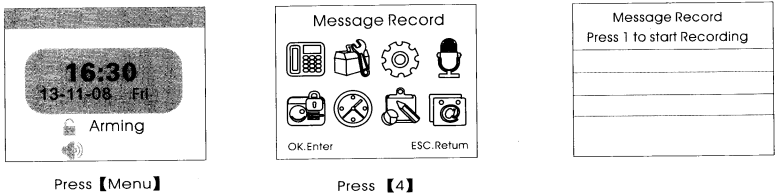

Picture 5-3

As picture 5-3, press → Press to enter voice alarm recording → press **[1]** to start recording , speak warning alert to the panel for recording. System will record 10 seconds and then automatically exit. Message should be simple like "This is whose house be intruded, please help".

2.2 Delay/Time Setting

2.2.1 Set delay for system arm

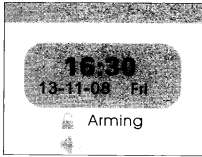

Press **【Menu】**

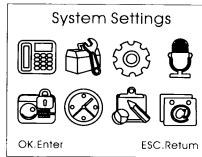

Press **【3】**

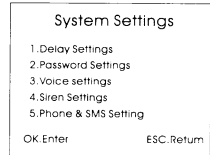

Picture 5-4

As picture 5-4, press  → choose  → **【1.Delay settings】**, input the delay time 0-99 seconds after **【Arming delay】**, “0” means arming without delay.

2.2.2 Set the time of delay for alarming

As picture 5-4, choose **【1.Delay Setting】** press  → Choose **【Alarm Delay】** → then input (0-99 seconds) you want. '0' means no delay.

2.2.3 Set the time of alarm system

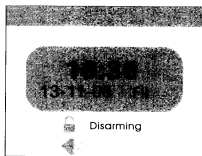

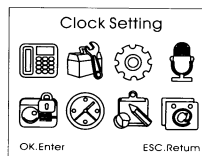

Press Menu button

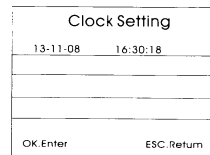

Press 6 button



Picture 5-5

As Picture 5-5,  →  → input the date and time as picture, press  to save.

Note: 2.2.1, 2.2.2 and 2.2.3 can be set by APP page 2 Time set :

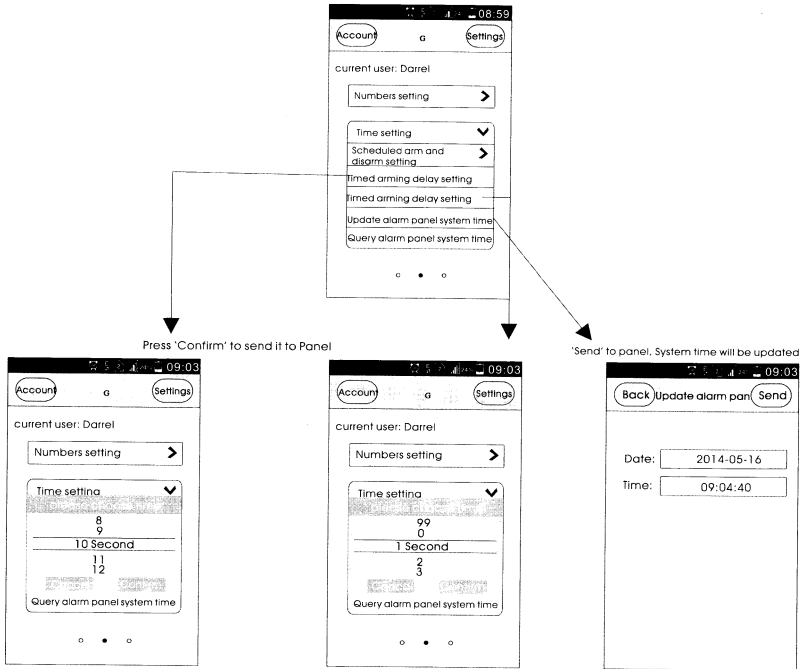

SMS Setting for 2.2.1 Arm Delay : 1234+51+(0-99)+ #

2.2.2 Alarm Delay: 1234+52+(0-99)+ #

2.2.3 System Time: 1234+56+Year(4 digits)+Month(2digits)+Date (1-31)+Hour (0-23)+Minute(0-59)+Seconds(0-59)+ #



2.3 Set the alarm system password with two methods

Method 1 : As picture 5-4, press **【2.Password Setting】** , input four new password behind **【Password】** (the original password is 1234).

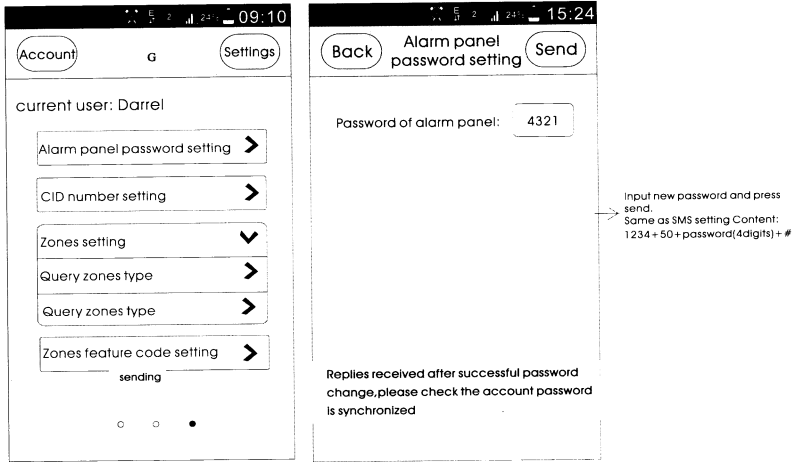
Method 2: Change it by APP Page3:



2.4 Set keyboard password protection feature

As picture 5-4, press **【 2.Password Setting 】**, press , choose **【Keypad Lock】**, input new password (4digits) and press  to save. Press the  switch ON or OFF.



2.5 System voice volume adjustment

As picture 5-4, press **【3.Voice Setting】** → press  → **【System volume】** → input volume level (1-7), Press **【OK】** to save.
SMS setting: 1234+79+digit(1-7)+#

2.6 Set system voice ON or OFF

As picture 5-4. press **【3.Voice Setting】** → **【System voice】**. press  switch ON or OFF.

2.7 Set the external alarm volume

As picture 5-4,press **【4.Siren Setting】** →press  button →choose **【External volume】** , input 00-99, 99 the maximum sound→press 

2.8 set the Internal alarm volume

As picture 5-4,press **【4.Siren Setting】** ,→choose **【Built-in volume】** →input 0-7, 7 the maximum sound→press  .



SMS setting: 1234+87+digit (0-7)+ #

2.9 Set length of Siren sound

As picture 5-4,press **【4.Siren Setting】** ,→ **【Siren on time】** ,input 0-20 minutes. 0 means no siren.



SMS setting: 1234 + 53 + Minutes(0-20) + #

2.10 Set times of rings for monitor call

Picture 5-4, press **【5.Phon&SMS setting】** →press  button →choose **【Ring time】** →input 0-20→  to save. 0 means refuse monitor call

SMS Setting: 1234 + 18 + times(0-20) + #

2.11 Set the anti-tampering of telephone call ON/OFF

As picture 5-4, press **【5.Phon&SMS setting】** → **【Test line】** →press  switch ON or OFF→ 

2.12 Set the SMS Messaging reply ON/OFF

As picture 5-4,press **【5.Phon&SMS setting】** → **【SMS reply】** ,press  switch ON or OFF .

On means panel will reply after it receive SMS setting.

2.13 Set remote control sound



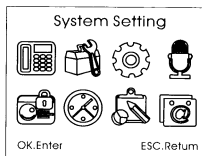

Press Menu button



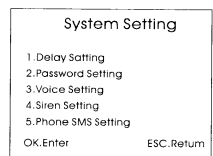



Press 3 button



Picture 5-4

As picture 5-4,press **【6.sound setting】** →Input Digit(01-99), 01 is lowest voice→ to save, press  to switch ON or OFF. 'On' means press remote, siren will "di di".

2.14 Scheduled arm and disarm with two methods (4 groups).

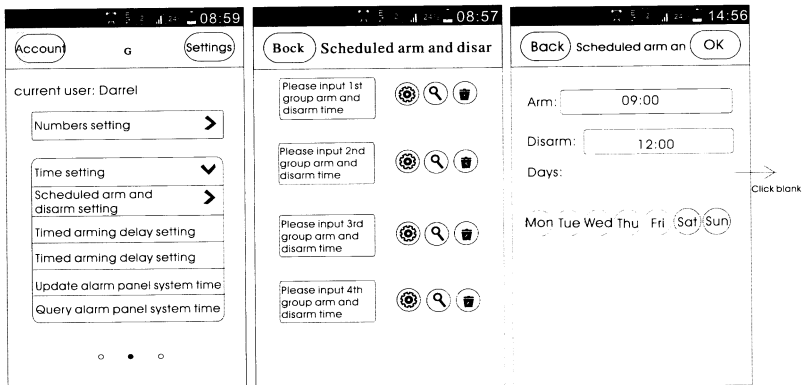

Method 1: As picture 5-4.press **【7.Timing Setting】** →Input Group Number (1-4)→ press  →input the Arming Time,Disarm time,Day (1-7 means Mon-Sun). (  to move the cursor.) Press  to save setting. Cursor to 'Timing on/off', press  to on/off it.

Method 2: Set from APP Page 2:



Input arm/disarm time and choose the day. Click 'OK', Click  to send. Same as SMS setting: 1234+57+Group(1-4)+Time Arm(4 digits)+Time Disarm(4digits)+ Day(1-7)+ #

2.15 Set the LCD 'Power Save' ON/OFF

As picture 5-4,press **【9.LCD Save&Tamper】** → **【LCD Save】** ,press  switch ON or OFF, Press  to save.

Same as SMS Setting: 1234+84+[1/0]+ # 1 for OFF, 0 for ON

2.16 Set Tamper ON/OFF

As picture 5-4,press **【9.LCD Save&Tamper】** → **【Tamper】** → switch ON or OFF. OFF means not alarm when tamper→Press to save.

2.17 Restore factory setting

AS picture 5-4,press **【0.Restore Factory】** → **【1 Part Recover】** →press. Accessories still there, DIY setting is removed.

Press **【0.Restore Factory】** → **【2 Full Recover】** → Long press for 10 seconds. All DIY setting and Accessories are removed.

SMS setting as: 1234+9898+#

3: DIY Zone Setting

On panel → , enter below:

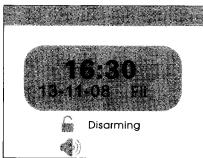

Press Menu button

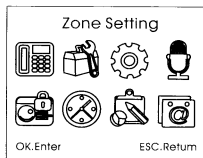

Press 5 button

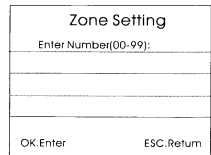

Picture 5-6

3.1. Set siren ON/OFF when Alarming with two Method.



Method 1 From Panel: As picture 5-6, →input zone No.(1-99)→press → move to **【Siren】** →press to switch ON/OFF.Off means siren not alarm for this zone→press to save.

3.2 Set the type of zone with 2 methods:

System default zone types are:

Normal	Stay	Intelligent	Help Senior	Chime	Welcome	Emergency
01-59	60-79	80-89	90	91	92	93-99



User can DIY every zone by two method:

Method 1 from Panel: As picture 5-6→Input zone No.(1-99)→press  → move to the **【Types】** →Press  to choose 1 of 8 kinds type→Press  to save



Method 2 from APP Page 3 for above:



3.3 Set zones banded with alarm phone number.

From Panel: As picture 5-6→input zones No.(1-99) →press  → move to **【Zone dial】** →input phone number group(1-6) →press  to save. (Help zones fix to help phone number group.)

3.4 Set NO /NC for wired zone

From Panel: As picture 5-6→Input wired zones No. (51-52) →press  → move cursor to **【Wired model】** →press  switch the NO / NC →press  to save.

Same as SMS setting: 1234+61 +Zone No.(51-52)+(0/1)+ # (0 for NO, 1 for NC)

3.5 Set SMS message content /Query the SMS message content of every zone by APP Page 3

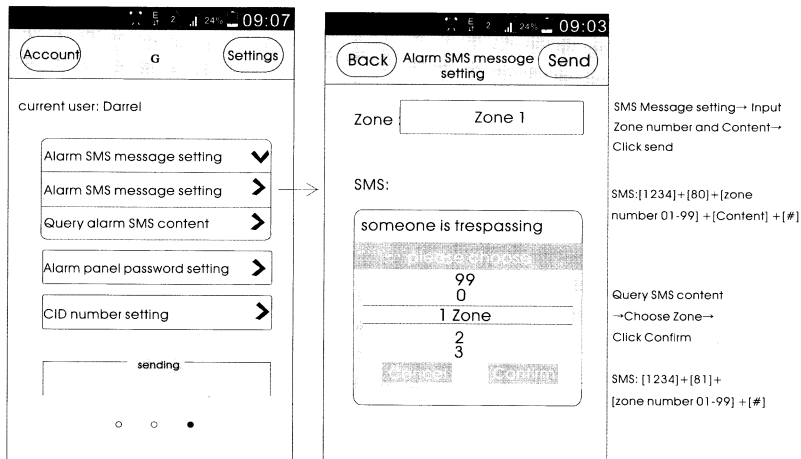

Part IV CID Monitor Center Setting

1, Set the phone number of CID center with 2 method:

On Panel: Press → Press → Choose CID number



Press **[Menu]**

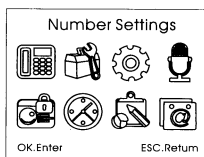

Press **[1]**

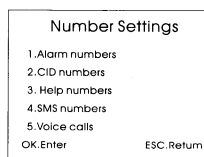

Picture 5-2

1.1 Input Contact ID phone number

Press to enter → choose group number (1-2) → input CID Center phone number → Press to save → press back to the menu.

Remark : If panel connect with line extension, please add a 'digit*' before the alarm phone number.

1.2 Delete Contact ID phone number

Enter **【CID number】** → press button to delete the number → press to save → Press back to the menu.

1.1 and 1.2 can be set By APP Page 2

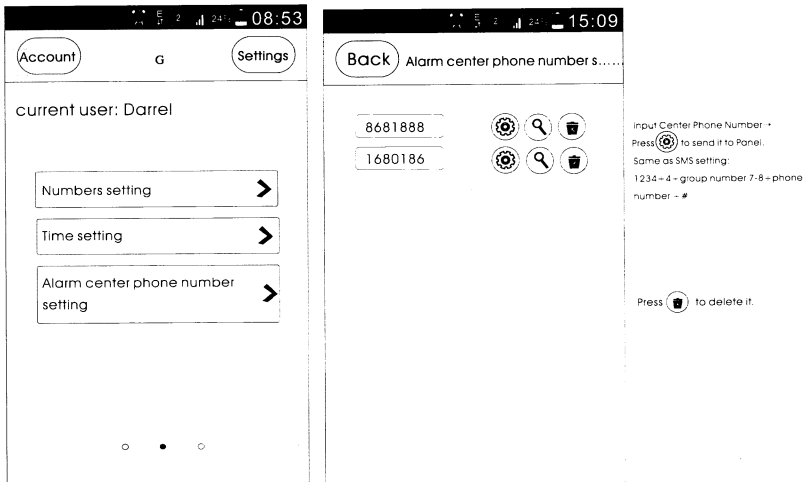

2. Set the User code for CID system

On Panel: → → **【8.CID setting】**



Press Menu button

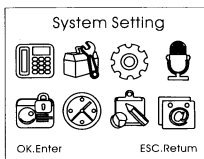

Press 3 button

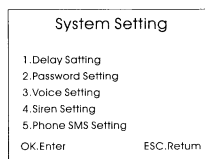

Picture 5-6

2.1 Set CID User Code

Set On Panel: Press to enter **【8.CID setting】** →input 4 digits CID coding behind **【User Coding】** →press to save.

Set On APP Page 3:

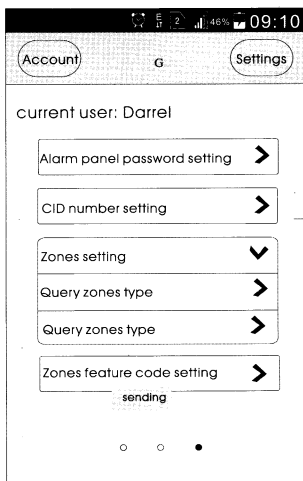

Click CID Number Setting

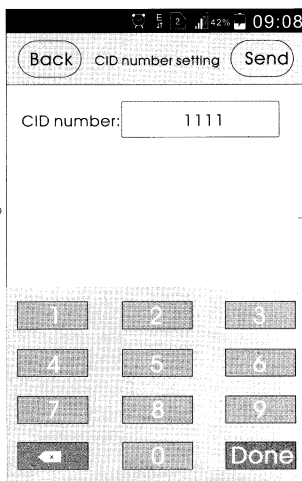

Input User Code, Click Send



Same As SMS Setting:
[1234]+[92]+
[AAAA 0-9] +[#]

3. Set the Signal Accuracy for CID

Set On Panel: Press to enter **【8.CID setting】** →Input the (0-9) to behind **【CID Accuracy】** →Press to save.

Set by SMS: [1234]+[83]+[Accuracy level 0-9] +[#] Normally Choose No. 4

4. Set the report of arm/disarm to CID

Set On Panel: Press  to enter **【8.CID setting】** → then press  behind **【Arm&Disarm】** to switch **【No sent】** / **【Arm】** / **【Disarm】** / **【All】** , press  to save

Set by SMS: [1234]+[91]+[0-3] +[#] 0 for No Report to CID 1 for report Arm to CID 2 for report disarm 3 for report ARM and DISARM

5. Set scheduled self-checking test time

Set On Panel: Press  to enter **【8.CID setting】** → input the self check test time behind **【Test Time (4 digits)】** → then press  to save

6. Set scheduled self-checking test day.

Set on Panel: Press  to enter **【8.CID setting】** → input the self check test day(1234567) behind **【Test Week】** → then press  to save (1~7 means Mon~Sun)

Set by SMS for 5.27+5.28: [1234]+[94]+[Self-checking time 4 digits] +[week number (1~7)]+[#]

7. Event Code Setting

On panel  →  , enter below:

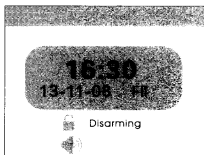

Press Menu button

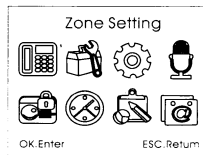

Press 5 button

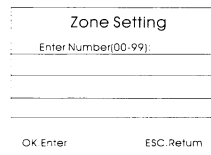

Picture 5-6

Setting CID event code

Set On Panel: Input Zone No.(1-99)→press  →input the event code behind **【 CID event codes】** . (100 is medical, 110 is fire, 121 is robbery, 122 is mute robbery, 130 is burglary, 131 is peripheral burglary, 151 is gas)

Set On APP Page 3, bar 'Zones feature code setting':

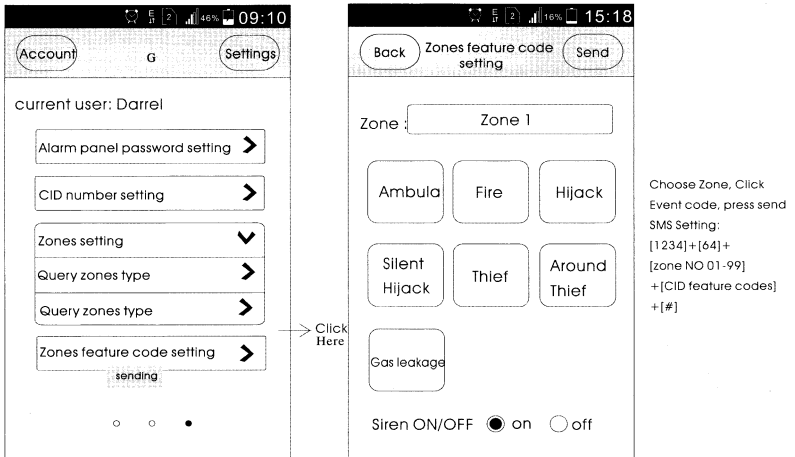

Part V Query Alarm System

1, Query [alarm list] or [Arm/Disarm List] record



Press Menu button

Press 7 button

Picture 5-8

Press → press → press to History list → choose [alarm list]/ [Arm/Disarm List]. The maximum 102 history record. Max 102 [Alarm List] and 72 [Arm/Disarm List]

2, Other SMS query.

Query the General Parameters : SMS:[1 234]+[1 1] +[#]

Query the arm/disarm status: SMS: [1 234]+[20] +[#]

Query the number of ring tones and anti-tamper: SMS :[1234]+[13] +[#]

Query the phone alarm number: SMS :[1234]+[30] +[group NO 01-06] + [#]

Query the Helpline number : SMS :[1 234]+[30] +[group NO07-09] + [#]

Query SMS number : SMS :[1 234]+[40] +[group NO01-06] + [#]

Query alarm center number: SMS:[1234]+[40] +[group NO 07-08] + [#]

Query the system date and time: SMS :[1 234]+[56]+[#]

Query the scheduled time of arm and disarm: SMS:[1 234]+[57]+
[group NO 01-04]+[#]

Query the defense zone type: SMS:[1234]+[60]+[zone number 01-99]
+[#]。

Query the alarm mode of the wired zone: SMS : [1234]+ [61]+[zone
number 51-52]+[#].

Part VI Default Factory Setting and System Parameters.

1 System default setting

Operation password	1234	SMS message	Enable
Remote Control	Enable	Number of ring tones before picking up	8 times
Siren sound	1 minute	Audible confirmation for remote operation	Enable
Delay ARM	0 s	Delay alarming	0s
Cut-line detect	Off	1-99 zone alarming	Siren sound
51-52 wired zones	NO	1-99 Zone SMS message content	Zone alarm

2 Fitting parameters:

Input voltage: DC9V-12V

Standby currents: <25mA

Alarm current: <450mA

Wireless frequency : 315/433MHz

GSM frequency : GSM850/900/1800/1900MHz

Back-up battery: Lithium Battery 7.2V

Alarm loudness: 110dB

Detailed parameters: Panel is compatible with Code PT2262, PT2240
and EV1527.

If sensor is PT2262 encoding, the resistance must be 1.5M-4.7M; If sensor is EV1527 encoding, the resistance must be 150K-470K.

Part VII How to Install Sensor

7.1, Installing Door or Window Sensor

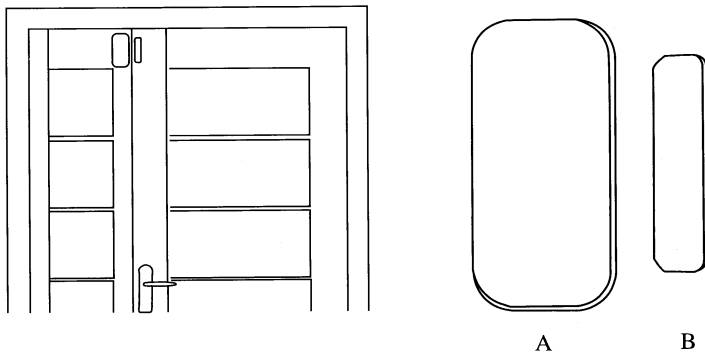

a. Firstly, user should clean the door/window surface before the door/window sensor locate.

b. Every door sensor include sensor (A as in diagram) and magnet (B as in diagram). B must be the right hand side. (A and B, one on fixed door frame, another one on movable door.)

c. A and B must be in a line, the distance between A and B shorter than 1 cm

d. Before installation, please use B to trigger A. (Trigger the LED light side, wrong side will not react.)

e. The light lit for one second, means normal. In case the door sensor's battery low, the indicator will keep lit as a low-voltage notification.

f. A, B can also be reinforced with screws, (A, bottom out, then screw in the bottom, buckle the cover to the bottom, B can be directly fixed on the screw back.)

7.2 Installing PIR Motion Sensor

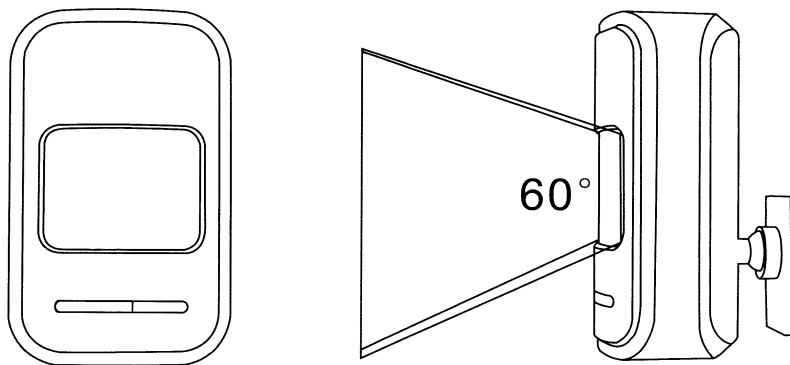

Notice:

- 1, Before use, make sure the PIR is powered ON.
- 2, Installation height is about 2.2 meters above ground
- 3, PIR should face the detected area for best coverage.
- 4, PIR should face perpendicularly to the moving of people.

Installation:

- 1, Reinforce bracket on the wall with screws.
- 2, Install the connector stick into PIR.
- 3, Press the ball head of the sticker into bracket.
- 4, Adjust the installation angle.

Attention:

1. In detection coverage, no obstacle.
2. Only 1 PIR in the same detection area.
3. Not face to window, cooling or warming machines, or other appliances that cause the temperature change sharply.
4. PIR need 5 minutes to adapt to environment before working.
5. Indoor use.
6. When intruder is detected, PIR will take seconds to confirm detection, then transmitter signal to avoid fault alarm and missed alarm.

Part VIII. Troubleshooting

Troubleshooting

Reasons

Methods

Troubleshooting Reasons Methods

1. No dial for alarm1. no arming
2. alerting phone no unsetting
3. parts improperly installed, distance too far away
4. code no match

1. do arming operation
2. re-set according to the specification
3. coordinating the location of parts
4. re-coding

2, Can't long-distance operate

password input wrongly

password input or changed to new password Or forced always clear factory set back

3, no ISD recorded voice prompt when alerting

ISD Voice prompt un-recorded

Record it again according to user manual

4, remote controller no work

1. coding unmatched with the host
2. insufficient power
3. battery pieces poor contact or corroded
4. unmatched with host

1. re-coding
2. change battery in the same type
3. eliminating the dirt on the pieces caused by corrosion
4. contact the local dealer to change the matched remote controller

5, infrared detector no work

low power

change to the same type battery

6, Infrared Beams not work

1. not power on
2. Electrically shorted
3. Beam tube dislocation

Power on
Reconnect wire
Adjust beams

7. siren no sound

1. siren plug or jack in short circuit or broken-line
2. plug line in short circuit
3. siren closed

1. repair or change plug or jack
2. change the jack line
3. set siren ringing time on the host

8. The transmitter distance for host is shortened

1. a nearby emitter is sending code
2. host receiver stoppage
3. standby battery of the host insufficient

1. find the interfering source and eliminate it
2. post back to the factory for amendment
3. check host power whether plugged well

9. Consistently alarm once power open

Telephone lines not connected and telephone lines anti-tamper function activated

Connect telephone line or close anti-tamper line function

